

Small Poultry Flocks

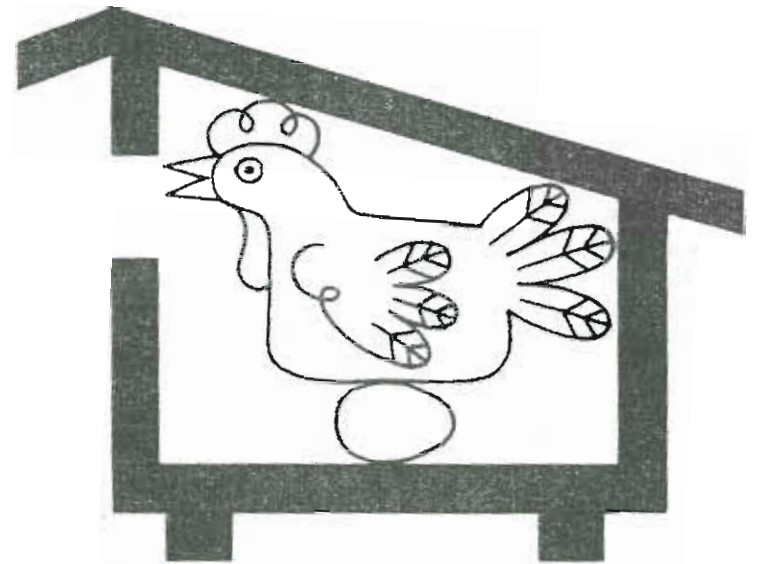

UNITED STATES
DEPARTMENT
OF AGRICULTURE

FARMERS
BULLETIN
NUMBER 2262

CONTENTS

Foreword	3
Laws	3
Flock Size	3
Starting a Layer Flock	3
Pullets	3
Second-year Layers	4
Day-old Chicks	4
Hatching Chicks	4
Combination Flock—Meat and Egg Production	4
Meat Production Flock	5
Incubators for Hatching Chicks	5
Brooding Chicks	5
Brooders	5
Brooder Houses	7
Brooder House Management	7
Outside Electric Brooder	9
Artificial Lights	9
Plans for Outdoor Electric Brooder	10
Plans for 10' x 10' Brooder House	13
Layer Houses	15
Plans for 20' x 20' Layer House	16
Layer House Equipment	15
Floor-type House	15
Cage Houses	21
Litter in the Layer House	21
Feed	21
Egg Handling	24
Culling	24
Force Molting	25
Cannibalism	25
Debeaking	25
Disease Prevention	26
Sanitation	26
Management Practices	26
Vaccination	26
Parasite Control	27
External Parasites	27
Internal Parasites	27
Fly Control	27
Home Dressing of Poultry	28
Slaughter	28
Feather Removal	28
Evisceration	28
Packaging	28
Storage	29
Laws	29

Foreword

Family poultry operations have gained popularity in recent months. These small poultry flocks provide a means of producing high quality food products at home as well as an opportunity for young people to learn the responsibility of caring for animals. Production of eggs and poultry meat at home is not always economical. Each individual should consider his own economic situation before starting the home flock.

This bulletin is designed to assist those individuals who wish to maintain a small poultry flock either for producing eggs or meat or as a hobby. General management principles are discussed and suggestions are made on housing facilities, equipment, and methods of starting the home flock.

Laws

Inquire about local laws and ordinances before you plan or start a poultry flock. Zoning ordinances in cities and suburbs often prohibit poultry keeping.

Flock Size

Flock size will vary with each individual situation. In determining flock size, consider the purpose for which the flock will be used, the method of starting the flock, and the space available for poultry keeping.

A layer flock started with pullets will produce 15 dozen or more eggs per hen per year. Second-year layers will produce around 12 dozen eggs per hen per year. If the layer flock is started from day-old chicks, remember that approximately half of the chicks will be cockerels unless they are sexed at the hatchery. Also, allow for mortality during the growing period.

Broiler flock size will depend mainly on the number of broilers the family wishes to consume per week. You can have a continuous supply of broilers by starting a new flock of day-old chicks when the older flock is 4 weeks old and slaughtering one-fourth of the older flock at the age of 7, 8, 9, and 10 weeks.

Starting a Layer Flock

PULLETS

Most commercial pullets (female chickens less than one year old) are raised and sold by contract, and commercial growers

normally do not sell small numbers to individuals. However, occasional surpluses do exist and this may be a supply source.

A more probable source of pullets is from individuals, but these may not produce as many eggs as commercial pullets.

SECOND-YEAR LAYERS

Commercial layers are usually replaced after 12 to 15 months of lay. These layers can be purchased for a reasonable price and make an excellent home flock since they have been bred for high egg production. Second-year layers will go through a molting period during which they will drop and replace old feathers and stop producing eggs. After the molt they will produce good-sized eggs at a fairly high rate.

DAY-OLD CHICKS

The small flock can be established by purchasing and rearing day-old chicks. This method requires a higher initial investment since brooding facilities and equipment will be needed. Also, more risk is involved due to the possibility of losing chicks by disease outbreaks or management problems. Another disadvantage is that with straight-run chicks about half of the chicks will be cockerels. Cockerels from layer-type breeds are not satisfactory for home meat production.

HATCHING CHICKS

This method of starting a home flock has the same disadvantages as starting with day-old chicks. In addition, incubation facilities and equipment are needed, and there are risks and problems in obtaining and successfully hatching fertile eggs. However, many people obtain a certain amount of pleasure and satisfaction from hatching and rearing their own chicks.

Combination Flock — Meat and Egg Production

Small flock owners may wish to produce both eggs and meat for home use. The so-called "dual-purpose" breeds are excellent for this type flock. Breeds such as Rhode Island Reds, New Hampshires, and Plymouth Rocks are fairly good layers, and the cockerels of these breeds are satisfactory for home meat production.

Sex-linked crosses are also suitable for a combination flock. You would probably have to establish this type of flock by purchasing day-old chicks or by hatching fertile eggs.

Meat Production Flock

Commercial broiler chicks are not readily available to the small flock owner, but he might occasionally be able to purchase broiler chicks from a local hatchery. One source of stock would be to purchase day-old cockerels of the larger layer breeds, such as sex-linked crosses, from a commercial hatchery. An alternative would be to produce your own from crosses of the heavy breeds. Crosses between Plymouth Rocks and New Hampshires or Rhode Island Reds make fairly good broiler chicks.

Incubators for Hatching Chicks

Various makes and models of commercial incubators are available. There are two basic types of incubators, forced-air and still-air. Forced-air incubators have fans for air circulation, which helps to maintain a uniform temperature. Still-air incubators depend on natural ventilation through small holes. The other major differences in incubators are whether humidity is automatically controlled or supplied by a water pan and whether eggs are turned automatically or by hand. Small still-air incubators suitable for incubating approximately 30 eggs can be constructed at home with little expense.

Brooding Chicks

BROODERS

The most common chick brooder is the gas hover-type brooder. Electric hover-type brooders are frequently used for small flocks and for some large commercial flocks. These are available in various sizes and are made by several different companies. Battery-type brooders and infra-red brooding lamps are satisfactory. Chicks reared on wire floors, as is the case with battery-type brooders, should not be placed on a litter floor later due to their lack of resistance to coccidiosis. Brooders can be constructed that use ordinary light bulbs as the heat source. Plans and instructions for this type of brooder are given on page 10.

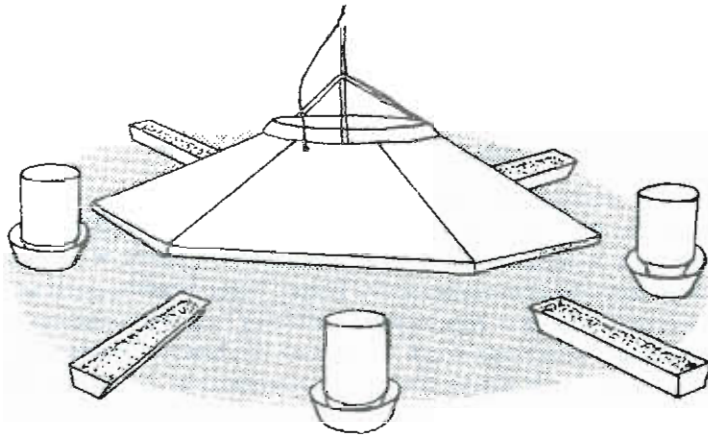

Figure 1.—Hover-type brooder

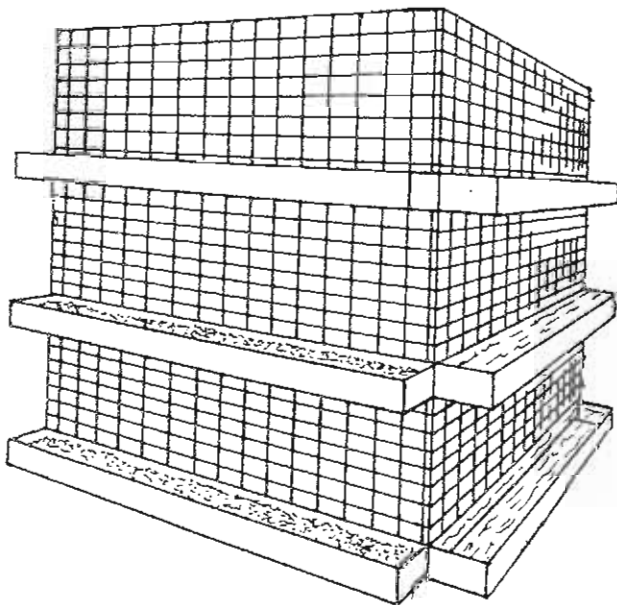

Figure 2.—Battery-type brooder

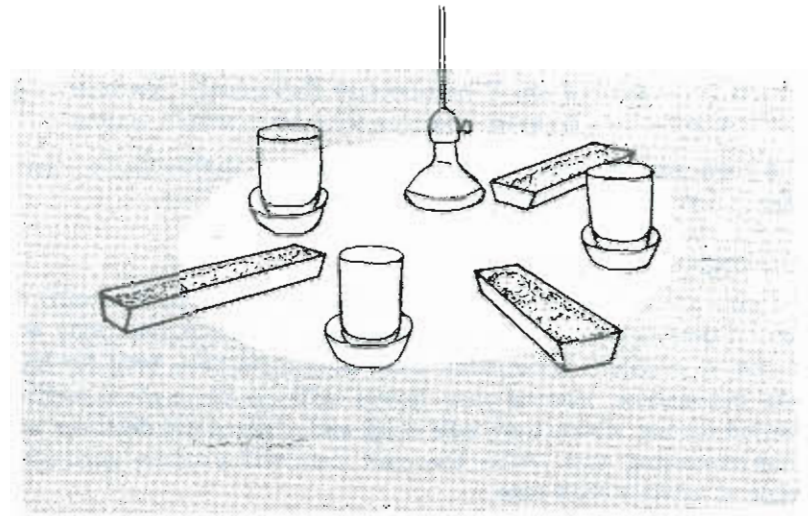

Figure 3.—Infra-red brooding lamp

BROODER HOUSES

Brooder houses can vary from the standard type poultry house to the outdoor electric brooder described in this bulletin. The brooder house has several basic requirements regardless of the type construction. Sufficient floor space is essential; one square foot per chick is recommended. Ventilation should provide plenty of fresh air but prevent the chicks from being exposed to drafts. Construction should be tight enough to make the house economical to heat.

BROODER HOUSE MANAGEMENT

Sanitation is important in any phase of poultry production. The brooder house and all equipment should be cleaned, disinfected, and allowed to dry several days before housing chicks.

In floor-type brooder houses the brooding area should be covered with at least 3 inches of absorbent-type litter. Wood shavings is the most common type poultry litter. Other materials, such as sawdust, peanut hulls, oat hulls, straw, ground corn cobs, and wood chips, can be used.

If the chicks are raised on wire floors, cover the floor with several layers of newspaper or other rough material for the first week. Do not use a slick material on the floor as young chicks will be unable to stand up and leg problems will result.

Start brooders at least 24 hours before chicks are placed under them. Adjustments can be made during this time and the house will be warm when the chicks arrive.

Temperature under the brooder at chick level should be 95°F during the first week. Lower the temperature by 5°F each week until a temperature of 70°F is reached. With infra-red lamp brooding, place lamps at least 18 inches above the floor to minimize the chances of fire. If the brooder temperature is incorrect, the chicks will either huddle close to the heat source (too cold) or stay away from the heat source (too hot).

With hover-type brooders or infra-red lamps, use a chick guard to confine the chicks to the brooding area for the first week. Eighteen-inch high corrugated chick guards, with a diameter 4 to 6 feet larger than the brooder, are satisfactory.

Adequate feed and water space is essential. From day-old to 4 weeks of age, provide at least 1 linear inch of feeder space per chick. One 4-foot feeder open on both sides is adequate for 100 chicks. However, it is advisable to have at least two feeders in each pen. After 4 weeks of age, provide from 2 to 3 linear inches of feeder space per chick. In addition to the regular feeders, place feed on rough cardboard flats or paper plates for the first few days. Remove them after chicks are eating from the regular feeders.

Chicks will waste feed if the trough is overfilled. Keep the feed trough full during the first week only, three quarters full the second week, and no more than half full thereafter. Adjust the height of the feeder so that the top edge is equal to or slightly higher than the bird's back. This will reduce feed wastage and help prevent litter accumulating in the feed trough. The chicks should be allowed to eat all of the feed out of the trough at least once each week. This will prevent old feed from accumulating in the trough. Remove all wet or moldy feed as this can cause disease problems.

From day-old to 4 weeks of age, provide two 1-gallon water fountains for each 100 chicks. After the fourth week add another 1-gallon fountain. Water fountains should be placed on a wire platform about 2 inches high. This will help prevent water spillage and keep litter out of the waterer. Clean the water fountain and fill with fresh water daily. If automatic waterers are to be used, start them as soon as the chicks are able to drink from them,

but do not remove other fountains until all the chicks have started drinking from the automatic waterers. Adjust the height of automatic waterers in the same manner as described for feeders.

Outside Electric Brooder

This brooder is simple to construct and relatively inexpensive. The unit is designed to rear 50 chicks to broiler size. However, the heating area itself can take care of up to 150 chicks, and the capacity of the unit can be increased by enlarging the sun porch area. One square foot of floor space should be provided for each chick grown to broiler size. The hardware cloth floor of the heating area should be covered with several layers of newspaper or other rough paper material for the first week to 10 days.

Heat for this unit is provided by four 40-watt bulbs and is controlled by a wafer thermostat. During cold weather it may be necessary to increase the size of the bulbs to maintain sufficient heat.

Artificial Lights

Lighting programs will vary depending on whether the chicks are to be grown for broilers or layers. In either case have all-night lights in the brooder house for the first 3 weeks. These lights do not need to be bright, but they should provide sufficient light for the chicks to find their way around the pen.

Broiler chicks can be placed under 14 hours of light daily after the third week or kept under 24 hours of light for the entire growing period. For chicks that are to be raised for layers, light should be restricted during the growing period to delay sexual maturity and then at about 21 weeks increased to stimulate egg production. During the laying period layers should have 14 to 16 hours of light per day, and they should never be exposed to a decreasing light-day. Natural daylight reaches a maximum length during June and then begins to decrease. Artificial lights should be used to hold the light-day constant and prevent layers from being exposed to a decreasing light-day.

A time clock can be used to turn the lights on or off automatically. Use both morning and evening lights to lengthen the light day. For morning lights set the clock so that lights come on before sunrise and go off after sunrise; evening lights should come on before sunset and go off after sunset.

PLANS FOR OUTDOOR ELECTRIC BROODER

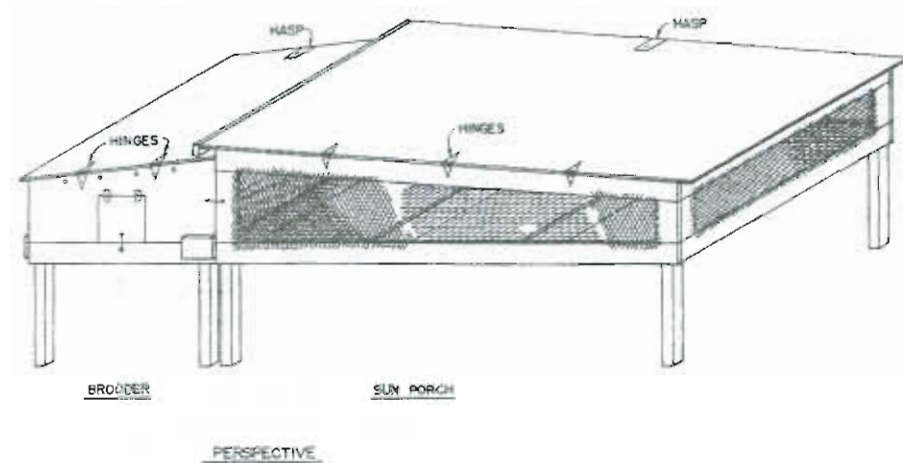
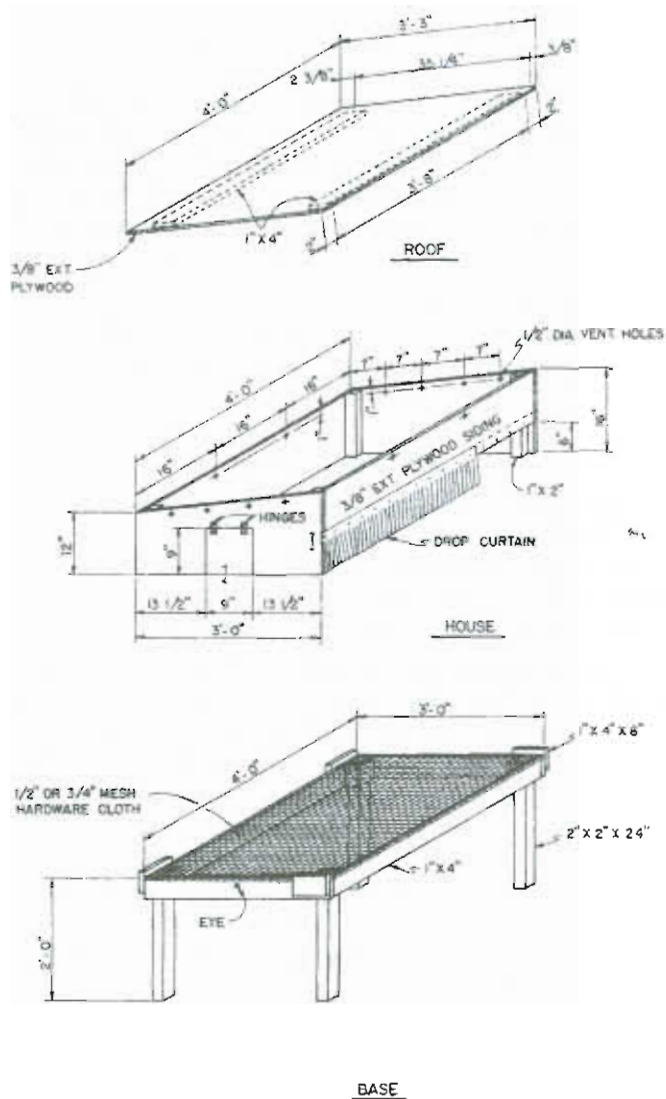

BILL OF MATERIALS

BROODER

- 1 SHEET 4'-0" X 8'-0" X 3/8" EXTERIOR GRADE PLYWOOD
- 1 - 1" X 2" X 4'-0"
- 4 - 1" X 4" X 10'-0"
- 1 - 2" X 2" X 10'-0"
- 1 PR SMALL HINGES
- 1 6d COMMON NAILS
- 1/2" Bd COMMON NAILS
- 4 LIN FT. 1/2" OR 3/4" MESH HARDWARE CLOTH 3'-0" WIDE
- DROP CURTAIN 7" X 48"
- 3 LARGE SCREEN DOOR HOOKS & EYES

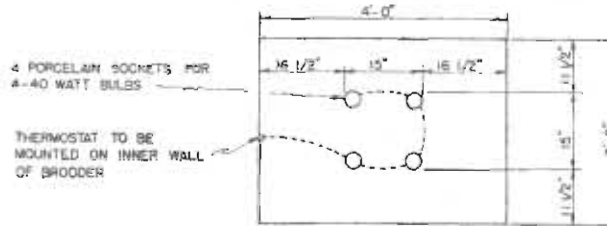

ELECTRICAL LAYOUT FOR BROODER

BILL OF MATERIALS

SUN PORCH

- 10 - 1"x4"x8'-0"
- 20 LIN. FT. 1" MESH POULTRY WIRE 3'-0" WIDE
- 6 LIN. FT. 1/2" OR 3/4" HARDWARE CLOTH 3'-0" WIDE
- 2 - 2"x2"x8'-0"
- 1/2" 6d COMMON NAILS
- 1/2" 6d COMMON NAILS
- 1" WIRE STAPLES
- 1 PIECE 4'-0" x 8'-0" x 3/8" EXTERIOR GRADE PLYWOOD
- 1 - 1"x2"x4'-0"

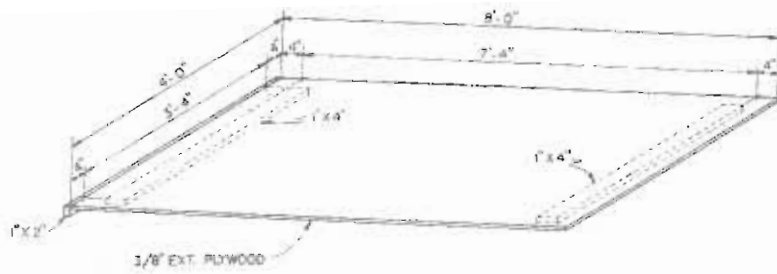

ROOF

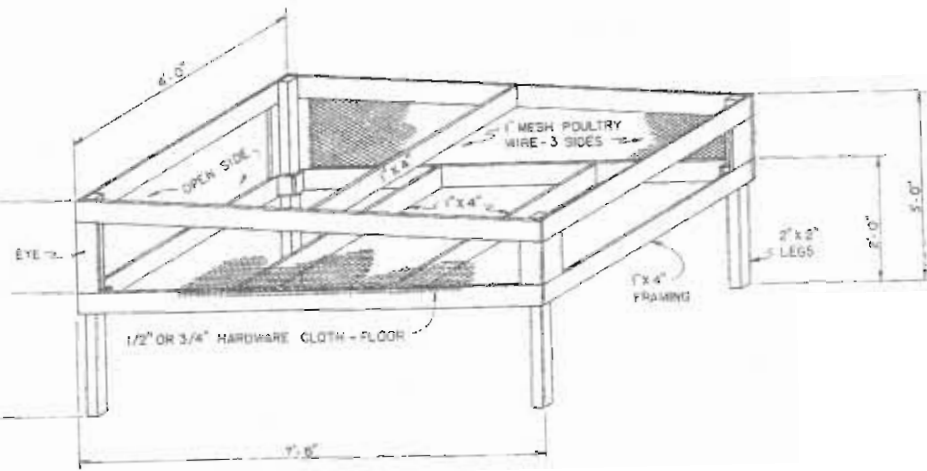

SUN PORCH

PLANS FOR 10' x 10' BROODER HOUSE

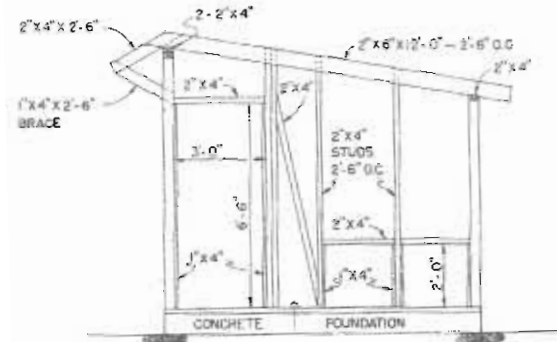

SIDE FRAMING

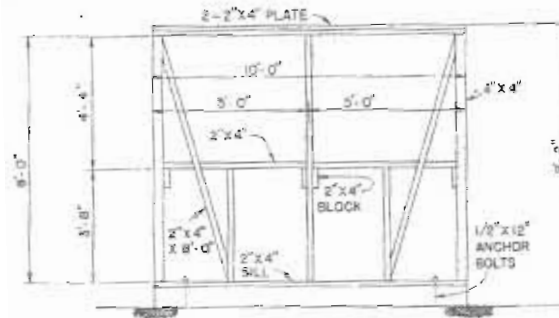

FRONT FRAMING

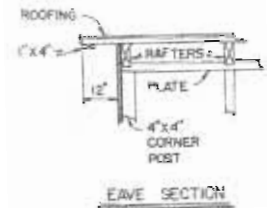

EAVE SECTION

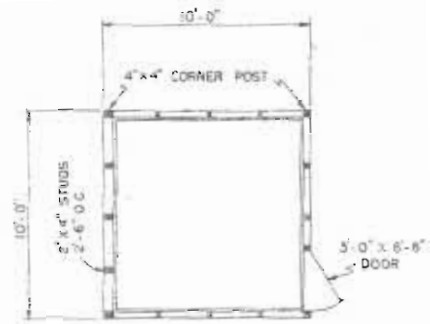

PLAN

(Plan continued on next page.)

Layer Houses

The small flock layer house does not need to be elaborate or expensive. The basic requirements of the house are that it provide sufficient floor space, protection from weather and predators, and be well ventilated but free from drafts.

With floor-type operations the layer house should provide at least 2 square feet per bird for light breeds such as Leghorns and 3 square feet per bird for the heavier breeds. The layer house described on page 16 provides a total of 400 square feet of floor space and is adequate for 200 Leghorns or 130 heavy breed layers.

Cover openings such as windows with 1-inch mesh poultry netting. During cold weather the openings can be partially or completely covered with polyethylene film if needed, but be sure to provide adequate ventilation.

Layer cages are excellent for a small home flock. Cages can be installed in any small building or a shed-type building can be constructed especially for cages.

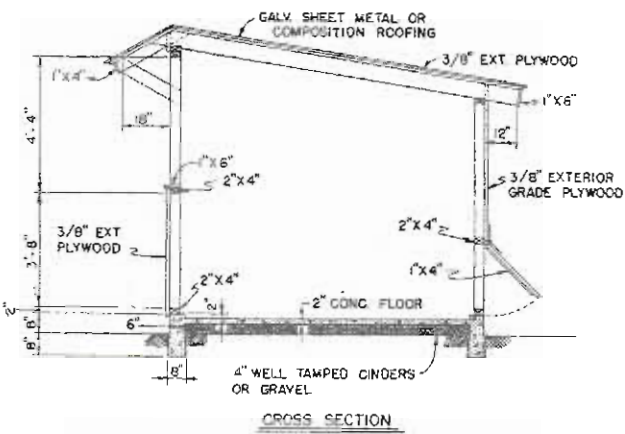

CROSS SECTION

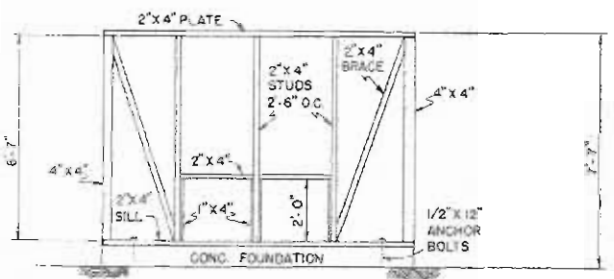

REAR FRAMING

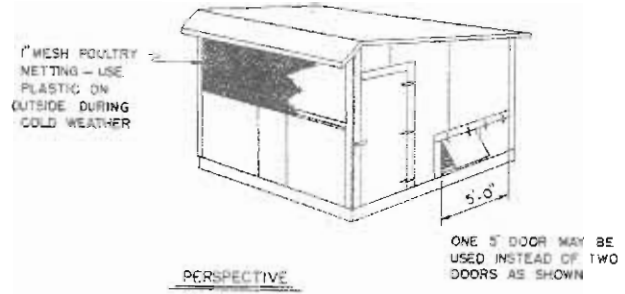

PERSPECTIVE

Layer House Equipment

FLOOR-TYPE HOUSE

The layer house must be furnished with the following equipment: feeders, waterers, nests, and lights. Besides these items, the furnishings might include containers for granite grit and oyster-shell, droppings board or pit, and roost.

Provide at least three linear inches of feeder space for each layer. Two 8-foot troughs open on both sides are enough for 100 layers. Trough-type feeders can be purchased or constructed at home; see page 22 for plan. If tube-type feeders are used, provide five 15" diameter feeders for each 100 layers. Feeder height should be equal to or slightly higher than the height of the bird's back. Trough-type feeders should be equipped with reels to keep birds out of the troughs.

Clean, fresh water should be available at all times. If trough-type waterers are used, provide at least 1 linear inch of waterer space per layer. If fountain-type waterers are used, provide enough

PLAN FOR 20' x 20' LAYER HOUSE

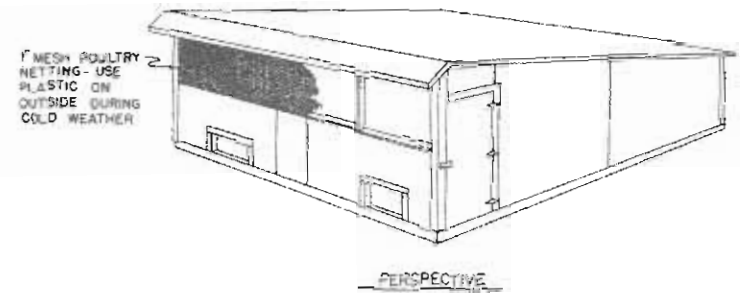
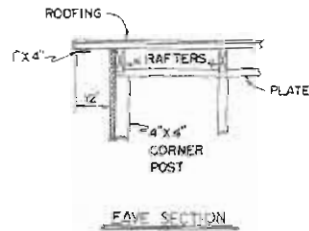
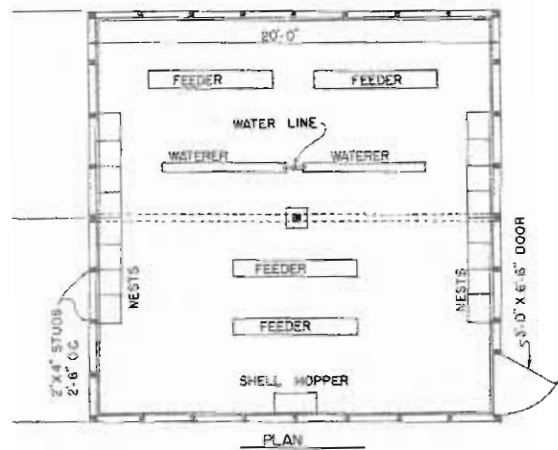
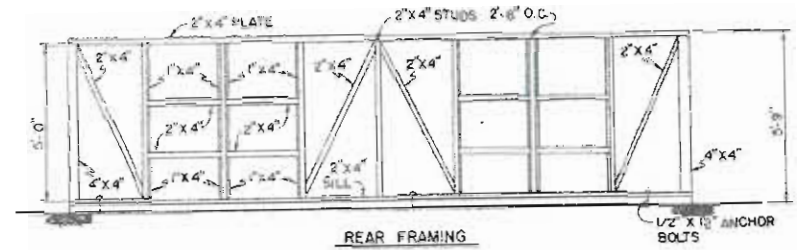
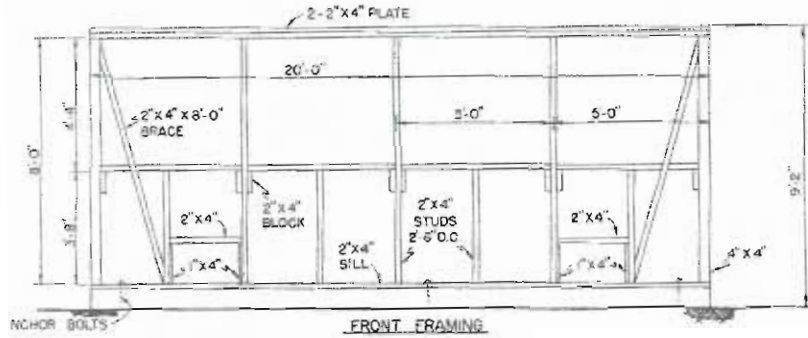
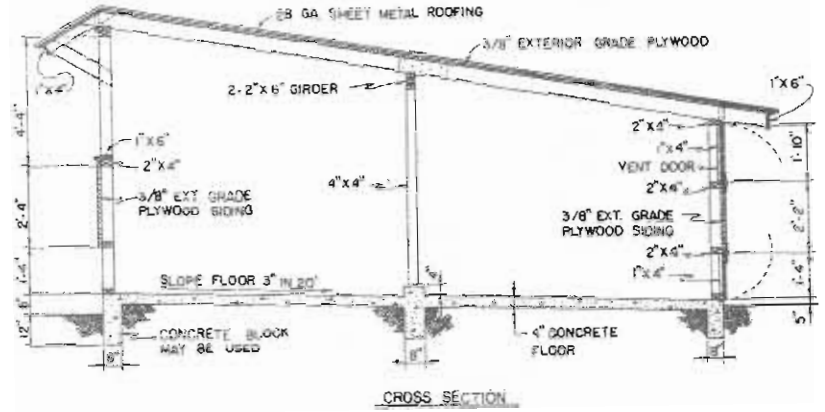
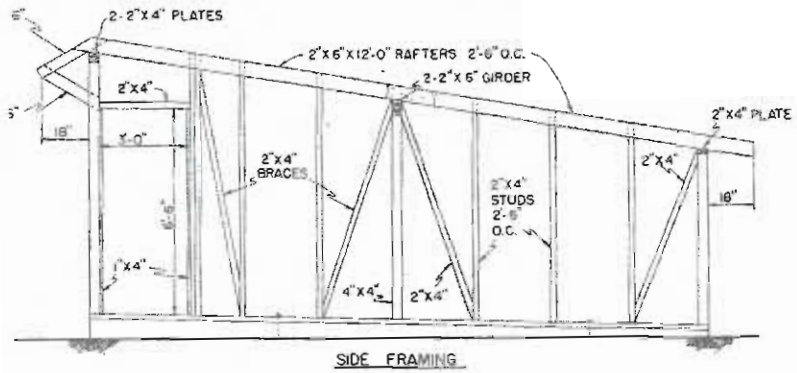

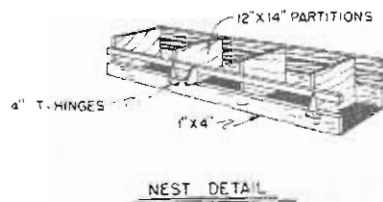
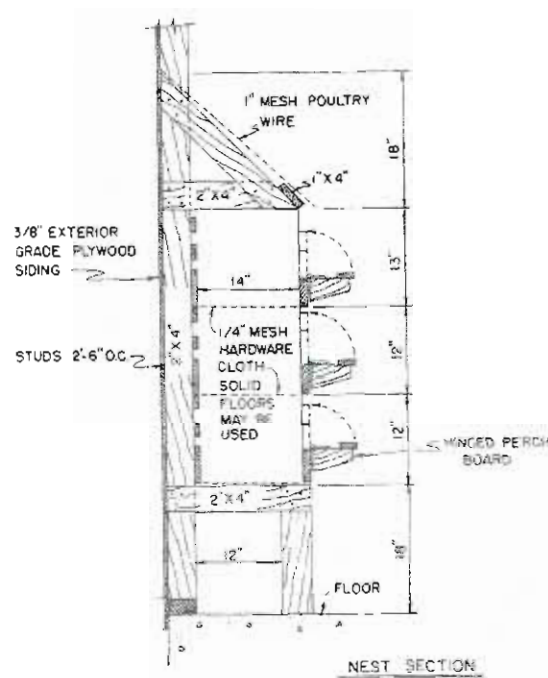

Nest section and detail for 20' x 20' Layer House

fountains to have a capacity of 7 to 10 gallons of water for each 100 layers. This will assure you of adequate water supply for 24 hours. Adjust height of waterers in the same manner as feeders. Fountain-type waterers can be placed on wire platforms about 4 inches high to help prevent water spillage and contamination of the water.

An adequate number of properly constructed nests will result in cleaner eggs and fewer broken eggs. Nests can be arranged in the center of the house or along the walls. Hens prefer a darkened area for nesting.

Nests may be individual nests designed to accommodate one hen at a time or community nests designed to handle several hens at once. Individual nests are usually 10-14 inches wide, 12-14 inches high, and 12 inches deep. Individual nests are usually arranged in rows several tiers high. Have perches below the entrance of the nest with the lowest nest being 18 to 20 inches above the floor. Provide an individual nest for every four layers.

Community nests are used by several layers at one time. These nests are usually about 4 feet wide and 2 feet deep and constructed similar to the one shown on page 20. One community nest this size is adequate for 40 to 50 hens.

Keep clean nesting material, such as wood shavings, in the nest at all times. Place nests in the house before hens start laying, or they will develop the habit of laying on the floor.

Lights are necessary to get good egg production in the winter months. One 40-watt light bulb 8 to 10 feet above the floor will provide enough light for 200 square feet of floor space. The cost of lighting the layer house is very little and will result in higher egg production during the winter months when egg prices are usually the highest. Refer to page 9 for lighting programs.

It is not necessary to feed granite grit to layers unless they are being fed whole grains. If a commercial layer ration is used, oystershell is not needed but can be fed if the diet is low in calcium. One linear foot of hopper space is adequate for 100 layers. The shell hopper shown on page 22 can be divided and used for both shell and grit. This will be adequate for 100 layers.

Droppings boards or pits and roosts are not considered to be necessary, but they do help prevent manure buildup in the litter. Roosts are usually placed over the droppings board or pit. Roost

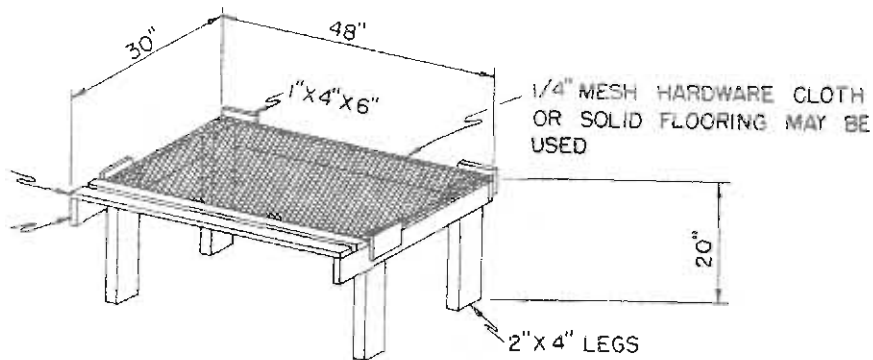
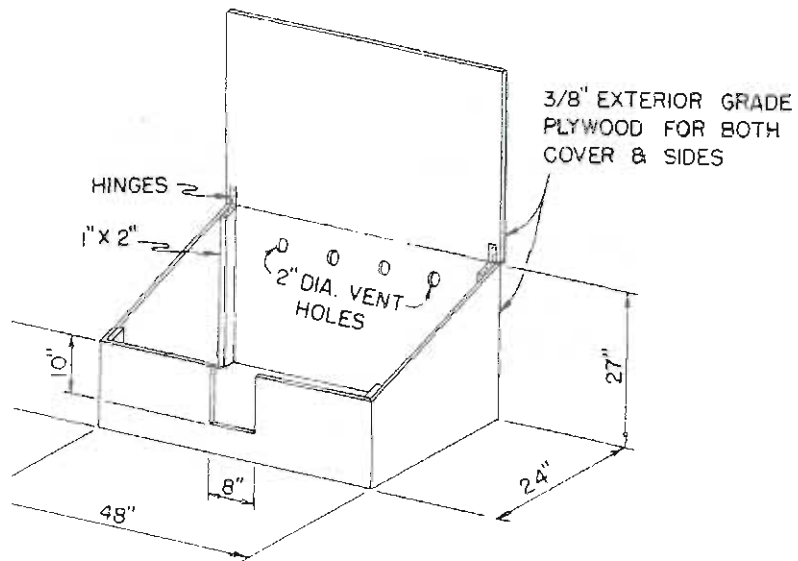

COMMUNITY NEST

poles can be made from 2" x 2" pieces with the upper edges slightly rounded. Roost poles should be placed 14 to 15 inches apart and should provide 8 inches of linear space per bird. Roosts should be 16-24 inches above the floor with 1" x 2" welded wire below the roost to keep hens out of the droppings.

CAGE HOUSES

Equipment for cage houses includes feeders, waterers, and lights. Commercial feeders and waterers are normally provided with the cages when they are purchased.

If oystershell is to be fed, scatter it on top of the feed rather than in an individual trough. Droppings pits and roosts are not used.

If the cages are in an open-type house, use curtains or polyethylene film on the sides of the house during the winter months. However, allowance must be made to provide adequate ventilation.

Litter in Layer House

Start with 4 inches of a moisture-absorbent litter, such as wood shavings. Keep the litter dry and in a loose, uncaked condition. Wet litter causes dirty eggs and increases the risk of disease problems. Preventing water spillage and leaks and providing proper ventilation will help keep the litter in good condition. Stir the litter when it becomes damp and packed. Remove any wet spots and replace with fresh litter.

Feed

The small flock owner will probably get the best results by feeding a commercial feed. Follow the recommendations of the manufacturer for the particular type of feed to use for various poultry. If instructions are not given by the manufacturer, use the following as a guide.

Layer chicks

0-8 weeks of age	Starter diet	20% protein
9-20 weeks of age	Grower diet	16% protein
After 20 weeks of age	Layer diet	15% protein

Broiler chicks

0-market age	Broiler diet	22-24% protein
--------------	--------------	----------------

Feed is the major expense item in producing poultry and eggs. For example, feed represents at least 60 percent of the total cost of producing eggs.

If local or home-produced corn is available, you may want to mix your own feed by combining a commercial protein concentrate with grain. However, a fairly large volume of feed must be mixed to make this more economical than purchasing commercial feed.

Proper combinations of grain and concentrate may be calculated by using "Pearson's Square." Place the desired protein content of the final mixture in the center of a square, protein content of grain in the upper left-hand corner and the protein content of concentrate in the lower left-hand corner. Subtract diagonally across the square to get parts of grain in the upper right-hand corner and parts of concentrate in the lower right-hand corner.

Example:

- Desired protein content of final mixture — 16%
- Protein content of corn — 9%
- Protein content of concentrate — 36%

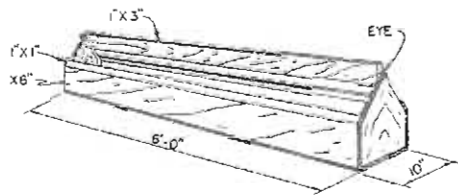
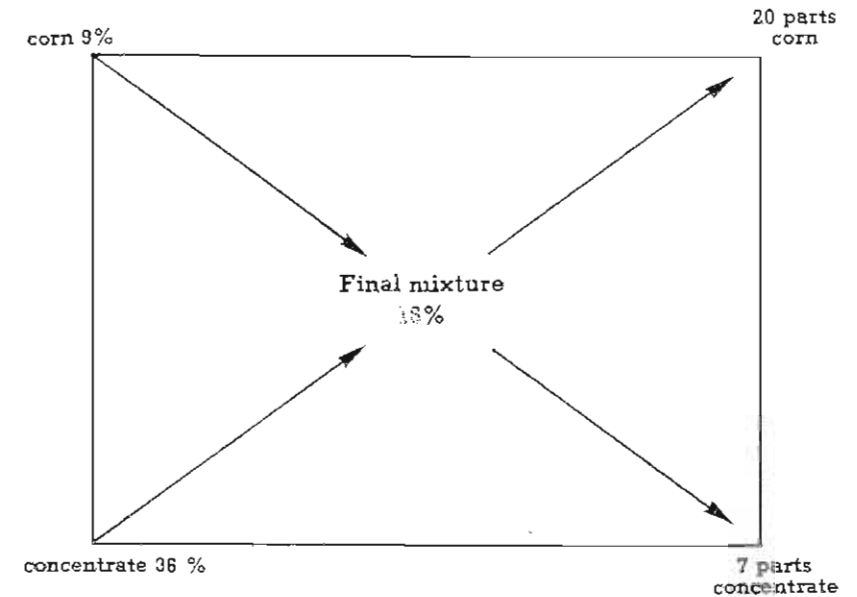

PERSPECTIVE

FEEDER

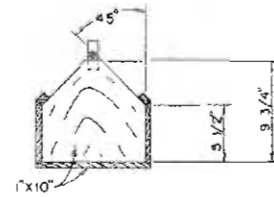

ELEVATION

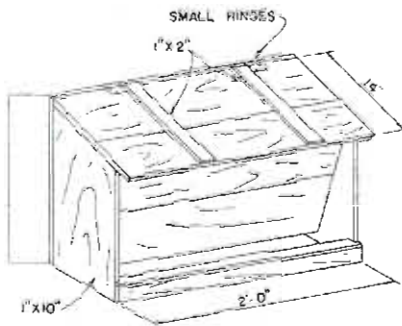

PERSPECTIVE

OYSTER SHELL HOPPER

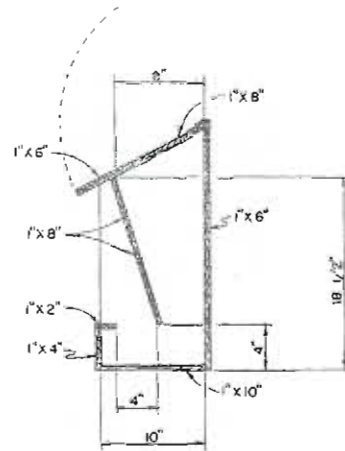

SECTION

This means that if you were going to mix 1,000 pounds of feed you would use $20/27 \times 1,000$ or 740 pounds of corn and $7/27 \times 1,000$ or 260 pounds of concentrate.

Egg Handling

Eggs should be gathered at least twice each day. More frequent gathering is recommended especially during extremely hot or cold weather. When eggs are allowed to stay in the nest the incidence of dirty and broken eggs increases. Besides dirtying other eggs in the nest, broken eggs encourages egg eating by the hens.

Dirty eggs should be dry cleaned or washed with an egg washing compound as soon after gathering as possible. The temperature of the wash water should be 100 to 120°F, and rinse water should be 5°F warmer than the wash water. It is better to leave eggs dirty than to wash in cold water.

Eggs should be dried, placed in clean cartons, and refrigerated as soon as possible after gathering and washing. Separate cracked and dirty eggs from the other eggs.

Eggs sold to retail stores must be graded by Federal or state standards. However, the producer can sell his own eggs directly to a household consumer without having them graded.

Culling

The layer flock should be culled frequently to reduce feed cost and eliminate possible disease carriers.

Good layers will have large, soft, red combs and wattles and bright, prominent eyes. The good layer will have a good body size, her vent will be enlarged and moist, and her pubic bones will spread apart and free from fat. Yellow pigmentation in the comb, eyering, earlobe, beak, and shank will disappear in good layers.

Nonlayers will have shrunken, pale, hard combs and wattles. Their body size will usually be small, their vents will be small and dry, and the pubic bones will be close together and covered with fat. When a hen stops laying, yellow pigmentation will return to the comb, eyering, earlobe, beak, and shank.

Force Molting

After layers have been producing for 10 to 11 months, the rate of production decreases and egg quality decreases to a point that it may not be economical to keep the flock in production. At this point the flock should either be replaced or force molted. If the price of replacement pullets is high and the present flock has had a good record as pullets and have been disease free, it may be economical to force molt the flock.

Force molting improves the production rate and egg quality above that which was being obtained before the molt, but production will not equal pullets in their first year of lay.

Cannibalism

Birds are naturally cannibalistic, and this tendency is increased when the birds are confined or placed under stress. Cannibalism can be caused by overcrowding, insufficient feed or water space, inadequate diet, improper temperature, or the sight of blood on another bird.

Cannibalism can be reduced or prevented by eliminating the stresses mentioned above along with the use of low light intensity and prompt removal of dead or injured birds. Debeaking the birds does not eliminate the tendency for cannibalism, but it does reduce the bird's ability to cause injury and may be the only cure once cannibalism has started.

Debeaking

Chickens can be debeaked at any age or whenever the need arises. A common practice is to lightly debeak day-old chicks and debeak again at about 16 weeks of age. Another common practice is to debeak at approximately 10 days of age.

Debeaking can be done by removing part of both beaks or part of the upper beak only. Occasionally, when the upper beak only is debeaked, the lower beak will grow too long and the bird has difficulty in eating. It may be necessary to remove part of the lower beak 3 to 4 months after removing the upper beak.

With electric debeaking approximately half of the upper or both beaks is removed, and the cut is cauterized with a hot blade. In a small flock debeaking can be done with a sharp knife or toe nail clippers, but the beak must not be cut deep enough to cause bleeding.

Disease Prevention

The success of disease prevention depends on sanitation, good management practices, and vaccination. Disease prevention is far more effective and economical than disease treatment.

SANITATION

All houses and equipment should be thoroughly cleaned and disinfected before new birds are housed. This is especially important for brooding and rearing facilities. Sanitary practices should be continued throughout the life of the birds. Water fountains should be cleaned and filled with fresh water daily. Wet or moldy feed should be removed from the feeders. Wet litter should be removed and replaced. It is not recommended that complete cleaning of the house be done during the life of the flock.

MANAGEMENT PRACTICES

Provide plenty of water, feed, and floor space. Proper temperature and adequate ventilation is a must. Young birds are susceptible to diseases carried by old birds and should be kept separate from older birds. Provide the birds with a well-balanced diet to keep them healthy and disease resistant. Control disease carriers such as wild birds, rodents, and insects. Remove sick or dead birds from flock as soon as they are found.

VACCINATION

Vaccines are available for several of the common poultry diseases. All chickens should be vaccinated for infectious bronchitis, Newcastle, and fowl pox. Commercially grown pullets are normally vaccinated for these diseases plus Marek's disease. Vaccination for Marek's disease is done at the hatchery. For vaccination to be effective, a sound program must be established and followed.

Parasite Control

EXTERNAL PARASITES

Mites and lice are the most common external parasites found on chickens. Many times these parasites are brought into the chicken house by wild birds. Insecticides, such as malathion, Co-Ral, and Rabon, are effective in controlling mites and lice. Consult the **Agricultural Chemicals Handbook** or your local County Extension Office for instructions on proper use of these materials. **Follow instructions!** Insecticides can be extremely dangerous when improperly used! Use only insecticides that are cleared for use on or around poultry. **Read the label.**

INTERNAL PARASITES

The primary internal parasites of poultry are roundworms, cecal worms, capillary worms, gapeworms, and flukes. Good sanitation and management practices will prevent and control worms. For treatment, use a worming compound recommended for the specific worm involved or a combination wormer for multiple worm infection or where the worm involved is not known.

Broilers can be treated every 2 weeks if necessary, starting the fourth week of age. For layer replacement stock, worm at 8 weeks of age and once per month thereafter if necessary.

Fly Control

Fly control is important both from the standpoint of the poultry operation itself and for maintaining good relations with neighbors. In most cases fly problems are brought on by poor management of litter or droppings. Wet manure provides an excellent breeding area for flies. Keeping the litter and manure dry will help control flies, odors, and diseases.

If it becomes necessary to use chemicals for fly control, consult your local County Extension Office for advice and instructions.

Home Dressing of Poultry

Poultry can be dressed at home with little or no special equipment. The primary concern during dressing is sanitation. Use clean equipment and prevent contamination of the carcass with fecal material or the contents of the crop or intestine.

SLAUGHTER

Hang the bird by its feet, sever the jugular vein behind the lower jaw, allow complete bleeding.

FEATHER REMOVAL

Immerse the bird completely for 60 to 90 seconds in water heated to 125-140°F. Test by pulling tail and wing feathers. Over-scald (too hot or too long) causes skin tears and loss of yellow color in the skin. Remove feathers immediately after scalding as rapidly as possible without tearing the skin.

EVISCEATION

Remove feet at the hock joint. Remove the oil gland on the tail — start 1 inch forward of the gland, cut to the tail vertebra then to the end of the tail. Cut the head off. Split the neck skin, starting from the shoulders and going to the end of the neck. Pull skin away from the neck. Remove crop, trachea, and esophagus and cut off neck.

With the bird on its back, cut around the vent and gently pull out until a few inches of the intestines are out. About 1½ to 2 inches below the point of the breast, make a horizontal cut about 3 inches long. Pull the vent and intestine through the horizontal cut and remove the viscera.

Remove the heart, liver, and gizzard from the viscera. Remove gall bladder from the liver, but avoid cutting the gall bladder. Split the gizzard from the edge of the large lobe and remove the yellow lining.

Remove the ovaries or testes and lungs. These are located in the bird's back. Be certain the body cavity is clean.

PACKAGING

Wash the carcass and giblets thoroughly. Chill in ice water 2 to 3 hours. Remove from chill water and drain. Place giblets in

small plastic bag or wrap in wax paper. Place giblets in crop area of carcass. Place legs of the carcass under the strip of skin left after the horizontal cut below the breast. Place carcass in plastic bag, draw out as much air as possible, and tie the bag with a wire tie. Air can be forced out of the plastic bag by submerging the bag in water to a point above the carcass.

STORAGE

Dressed poultry can be stored in the home refrigerator for several days, but it should be frozen if it is to be stored for more than 7 days.

LAWS

Federal law requires that all poultry dressed for sale be processed in plants inspected by the United States Department of Agriculture or in plants under state inspection that is equal to United States Department of Agriculture standards. A producer may process poultry for his own use without inspection, but he cannot legally sell any surplus dressed birds without inspection.

Prepared by

K. A. Holleman
Professor of Poultry Science
Clemson University

Acknowledgements

This publication has been adapted from Extension Circular 544, Clemson University, Clemson, S. C.

Special appreciation is extended to Dr. B. L. Hughes, associate professor, Poultry Science, who prepared most of the material for this bulletin.

Acknowledgment is also made to Dr. B. D. Barnett, head, Department of Poultry Science; J. B. Cooper, associate professor emeritus, Poultry Science; J. F. Welter, associate professor, Poultry Science.

Acknowledgment is also made to Mr. F. H. Hedden, associate professor, Agricultural Engineering, who helped develop the various plans in the bulletin. Plans may be obtained by requesting them from the Agricultural Engineering Department, McAdams Hall.